

MICAFLUID AG, Schweiz

VLP-05 Transformer On-Line Curing System

TABLE OF CONTENTS

| | | |
|------|--|----|
| I. | APPLICATION OF THE PLANT | 2 |
| II. | SPECIAL FEATURES | 3 |
| III. | TECHNICAL DATA / MACHINE SPECIFICATION | 4 |
| IV. | SCOPE OF SUPPLY | 5 |
| V. | OPTIONAL EQUIPMENT | 7 |
| VI. | DRAWINGS | 13 |

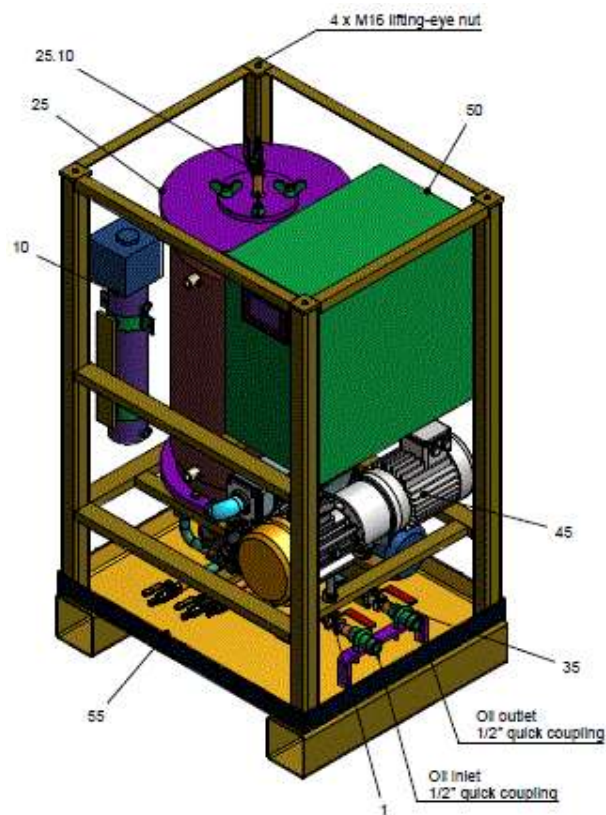

Sample picture of VLP unit

I. Application of the plant

General Information

Drying of transformers: The presence of moisture in the transformer, to whatever degree, does actual harm to insulation which is, in fact permanent damage. Drying methods only substantially reduce that deterioration. Vacuum Separator VLP-05 is intended for mobile and preferably preventative use on transformers with more than 2-2.5% water content in the cellulose, with particle contamination and excess gas. The quick restoration of safe dielectric conditions also forms part of the concept. The system can be installed regardless of the size of the transformer. Micafluid vacuum technology conditioning equipment for insulating oil has offered excellent service on the world market. Regular servicing of transformers with our equipment can substantially improve their lifetime and performance and on top helps to save money.

The new line of Micafil technologies oil treatment plants type TCC-05 with variable flow capacity, is designed for economical on-site conditioning and drying of Tap Changer Oil

The plant is designed for the following applications:

- On site drying of electrical apparatuses with simultaneous treatment of the oil. No disconnection of the transformer under treatment, normally not even during the installation of a separator.
- Degassing, dehydration and filtering of Transformer and Tap Changer Oil with variable oil through put
- First filling of electrical apparatuses with insulating oil.

Expectations of an oil plant for treatment of insulating oil:

- Low moisture content at plant outlet. Moisture, gas and particles content can be reduced to the level of a new transformer.
- Elimination of residual gas from the insulation.
- Drying of transformer insulation- No impact on the insulating oil properties, no over-drying of the transformer.
- Easy and safe operation.
- Quick restoration of dielectric strength of oil.

Working principles

The insulating oil is conveyed into the degassing tank by means of pressure difference. Oil is heated by indirect controlled heating system with less specific heat transfer of $1\text{W}/\text{cm}^2$, thus avoiding hot spots and no over-swinging of the pre-selected operating temperature.

The special degassing system and geometry of the degassing tank create a large oil surface and a resulting thin film for most effective maximum degassing. The TCC treatment system with higher end vacuum guarantees, besides others, that no light fractions are evaporated in the insulating oil. Whereby, the required characteristic of the oil is not changed.

An oil level regulation in the degassing tank assures a continuous oil flow-through in the plant, thus resulting in an optimised degassing.

After degassing and dehydration under vacuum, the oil is conveyed by means of a specially sealed and frequency controlled pump through the fine filter and out of the plant.

II. Special features

- The plant is delivered ready for operation. Installation and service with minimum manpower and energy.
- Continuously adjustable oil flow rate between 300 to 500 lt/h. The combination of special distribution elements with the automatic oil level control device, so called **OLC-System**, guarantees even oil distribution in the degassing column for best treatment values at any pre-selected oil flow.
- The plant is equipped with built-in control and safety devices, which provides for a maximum operating security.
- Minimised power consumption through optimised degassing (excellent efficiency factor).
- Standardized filtre housing for 1 micron or 5 micron filtre cartridges.
- Automatic supervision of the degree of contamination of the fine filtre cartridges (with option Z 5.1).
- All electric drive motors, as well as the separator are air-cooled. External cooling water connection is not required.
- All plants are PLC controlled with **Fail Safe Operation system (FSO)**.
- Micafluid oil plants are equipped with Viton seals for a guaranteed leakage rate of smaller than **0.025mbar x lt / sec.**
- On-line treatment on energized transformer Micafluid oil plants may acquire with a supplementary „on-line set“. This set will permit the operator to treat the oil on energized transformer.

III. Technical data / Machine Specification

The Micafluid oil treatment plant type VLP-05 is for oil treatment with a filling quantity of approx. oil contents 1 to 5 tons. This value is only depending on the treatment time in function of the total oil content.

Technical description of the plant:

| | |
|------------------------|------------------------|
| Maximum oil throughout | 10 m ³ /day |
| Operating vacuum | 1-9 mbar |

Power Consumption

| | |
|---------------------------|-------|
| Without oil heater | 850W |
| With oil heater | 5.5kW |
| Air condition unit | 300W |
| Overall Power Consumption | 5.8kW |

| | |
|--------------------------------------|--------------|
| Operating temperature | 60°C |
| Minimal oil temperature at the inlet | 10°C |
| Power supply standard | 3Ø, 480 Vac |
| Frequency | 60 Hz |
| Electrical equipment as per | IEC Standard |

Connections to oil treatment plant

| | |
|------------------------|--------------------------------|
| Oil inlet | DN15 |
| Oil outlet | DN15 |
| Outlet water content | 10 ppm nominal, 4 ppm maximum) |
| Outlet gas content | 1% nominal, 0.3% minimum |
| Outlet filtering grade | 1 µm |

| | |
|-----------------------------|--------------------|
| Painting of the plant | yellow / black. |
| Inscription on the plant in | German or English. |
| Operating instructions in | German or English: |

1 folds in paper form
1 on CD for use on Laptop

Note:

In the standard execution the oil treatment plant is delivered without power cable and oil hoses. These items are available as options; see optional items.

IV. Scope of supply

The basic equipment of the plant comprises the following components:

Item 1 1 oil inlet valve

Item 2 1 pressure indicator

Indicates the pressure at the inlet of the plant

Item 3 Coarse filter

with easy to clean filter insert

Item 5 Electro-magnetic oil inlet valve

Item 6 Oil flow indicator

The flow indicating unit has minimum and maximum switching point which can be adjusted. LED announcement on the equipment shows at whether oil flows or not. This announcement cannot be used as oil counters.

Item 10 Oil heater

The indirect heating of the oil is carried out by means of electrical resistance heating elements and thermofluid, which are separated from the oil by vacuum tight protection tubes. A very low specific heat load (less 1 W/cm²) guarantees a careful heating of the oil.

Item 15 Degassing tank

Degassing tank includes an oil distributor and degassing column. The oil distribution system guarantees a continuous oil flow at variable oil throughput.

Item 20 Feeding pump

Pump with vacuum-tight shaft seal, over pressure safety valve, direct drive motor. The oil throughput on this pump is continuously adjustable from the control panel via a frequency transformer.

Item 22 1 pressure indicator

For checking the filter resistance, respectively the degree of contamination of the filter. If the pre selected pressure will be higher, due the effect of saturated filters with dirt particles control system stop the plant. Fine filter must be changed.

Item 25 Fine filter

Equipped with all necessary valves, as well as easy to change filter cartridges with a fineness of 5 or 1 microns. The filter has a graded depth function, this in order that the coarse particles are retained in the outer layers and the finer particles only in the deeper filter layers.

Note: One set of spare filter is included. The filter housing is designed for the acceptance of 1 or 5 micron filter cartridges.

Item 30 Non-return valve

Prevents the oil flowing back into the plant, when the feeding pump is switched off (Item 20).

Item 35 Oil outlet valve

Item 45 Vacuum pump 25m³/h

The vacuum pump is air-cooled and equipped with a gas ballast device, as well as directly flanged-on drive motor. The gas ballast provides that water vapour will be exhausted without condensing.

Final vacuum: 0.5 mbar (Vacuum pump with GB open)
Operating vacuum: 1 to 9 mbar max (in the degassing chamber)

Item 50 Switch cabinet

Containing all electrical apparatuses, contactors, thermo-relays, fuses, press buttons and the main switch, etc. A condensed operating instruction is attached to the front side. PLC Logo system will control the main parameters of the plant.

Item 55 Base frame

With oil-tight tub, on which all elements are mounted, ready for operation. No on-site-erection or commissioning is required. The unit is delivered completely assembled, with quick coupling system for hose connection (Hoses not included see Z3).

Note:

According to standard the oil treatment plant are deliveries without electrical cable and oil hoses. These positions are available as options.

V. Optional equipment

The plant can be supplied with the following optional equipment:

| | |
|-----------|---|
| Z1 | Online Supervision control |
| | <p>The online supervision control is needed if the unit will be operating unattended on onload tap changer.</p> <p>The unit is equipped with PLC system and VPN router for remote control.</p> <p>Technical details see Z12</p> <p>Scope of supply:</p> <ul style="list-style-type: none"> - Industrial VPN 3G Router - Oil leak supervision (Option Z8) - Automatic shut off valve - Inlet and outlet temperature probe - Indication of values on touch screen |

| Z2.2 | Touch Screen 7" | | | | | | | | | | | | |
|---|---|------------|---|------------|------------|------|---------|------------|-------------------------|----|---------|------------|---|
|  | <p>All VOP plants are equipped with a HMI touch screen. This allows for interactive plant control whereby the following is possible:</p> <ul style="list-style-type: none"> • Process supervision • Setpoint definition • Fault supervision • Alarming • Process trending • USB data logging <p>The following STANDARD sizes are available:</p> <table border="1" style="width: 100%; border-collapse: collapse;"> <thead> <tr> <th>Size</th> <th>Resolution</th> <th>Dimensions</th> <th>Advantages</th> </tr> </thead> <tbody> <tr> <td>4.3"</td> <td>480x272</td> <td>149x109x56</td> <td>Compact size (standard)</td> </tr> <tr> <td>7"</td> <td>800x480</td> <td>187x147x51</td> <td> Extended size (Option Z2.2) <ul style="list-style-type: none"> • More trending features • Detailed process supervision • Quick access on screen help and troubleshooting guide </td> </tr> </tbody> </table> | Size | Resolution | Dimensions | Advantages | 4.3" | 480x272 | 149x109x56 | Compact size (standard) | 7" | 800x480 | 187x147x51 | Extended size (Option Z2.2) <ul style="list-style-type: none"> • More trending features • Detailed process supervision • Quick access on screen help and troubleshooting guide |
| Size | Resolution | Dimensions | Advantages | | | | | | | | | | |
| 4.3" | 480x272 | 149x109x56 | Compact size (standard) | | | | | | | | | | |
| 7" | 800x480 | 187x147x51 | Extended size (Option Z2.2) <ul style="list-style-type: none"> • More trending features • Detailed process supervision • Quick access on screen help and troubleshooting guide | | | | | | | | | | |

| | |
|---|---|
| Z2.5 1 Moisture content measuring instrument | |
|  | <p>New intelligence for direct check of dehydration efficiency by volumetric measurement of the separated water in oil. Versatile configuration options including graphical trend display with 1-year history.</p> <p>Measuring :</p> <ul style="list-style-type: none"> Channel 1: -20 to 100°C Channel 2: relative moisture |

| | |
|--|--|
| Z3 Hydraulic Connection 2 x 1/2" flexible hoses | |
|  | <p>Inlet/outlet hoses are flexible, heat and oil resistant, metal shielded or reinforced. Each 10 m long, for max. oil temperature 90°C, in oil and vacuum-tight design. Flange connection on transformer side and quick coupling at the side of the plant.</p> |

| | |
|---|---|
| Z8 Supervision of oil leaks | |
|  | <p>In case of an oil leak and cut-off of normal power supply in the plant, it has sensor and automatic switched-off for detection as soon as the oil reaches the probe, thus avoiding further oil spill.</p> <p>Note:</p> <p>This option is required for on-line treatment process on energized transformer. (Online process control upon request)</p> |

| | |
|---|--|
| Z9 Oil sampling measuring set | |
|  | <p>Special MICA-Sam plug for correct withdrawal of oil samples for testing purpose.</p> <p>This supplement contains:</p> <ul style="list-style-type: none"> 1 pipe socket 1 MICA-Sam system 2 withdrawal syringes |

Z12 Machine Virtual Assistance for Remote Monitoring & Control of the Drying Process

Machine Virtual Assistance or MVA is the all-in-one SUPPORT platform created by Micafluid AG.

MVA puts your organisation on the cutting edge by providing you with the latest tools required to ensure:

- **Safety**
- **Ease of operation**
- **Process quality**
- **Manufacturing and service deadlines**
- **Preventive maintenance.**

Features and Benefits

- Full support from the time you subscribe until you stop.
- Remote engineering, operation and process supervision.
- Communication bundled per zone, allowing for free movement cross border for mobile units.
- Organise processes for future reference, traceability, comparisons and reporting.
- Central database providing ticketing, online session and preventative maintenance reports.
- Trouble free annual subscription which covers your support needs well beyond the guarantee period.

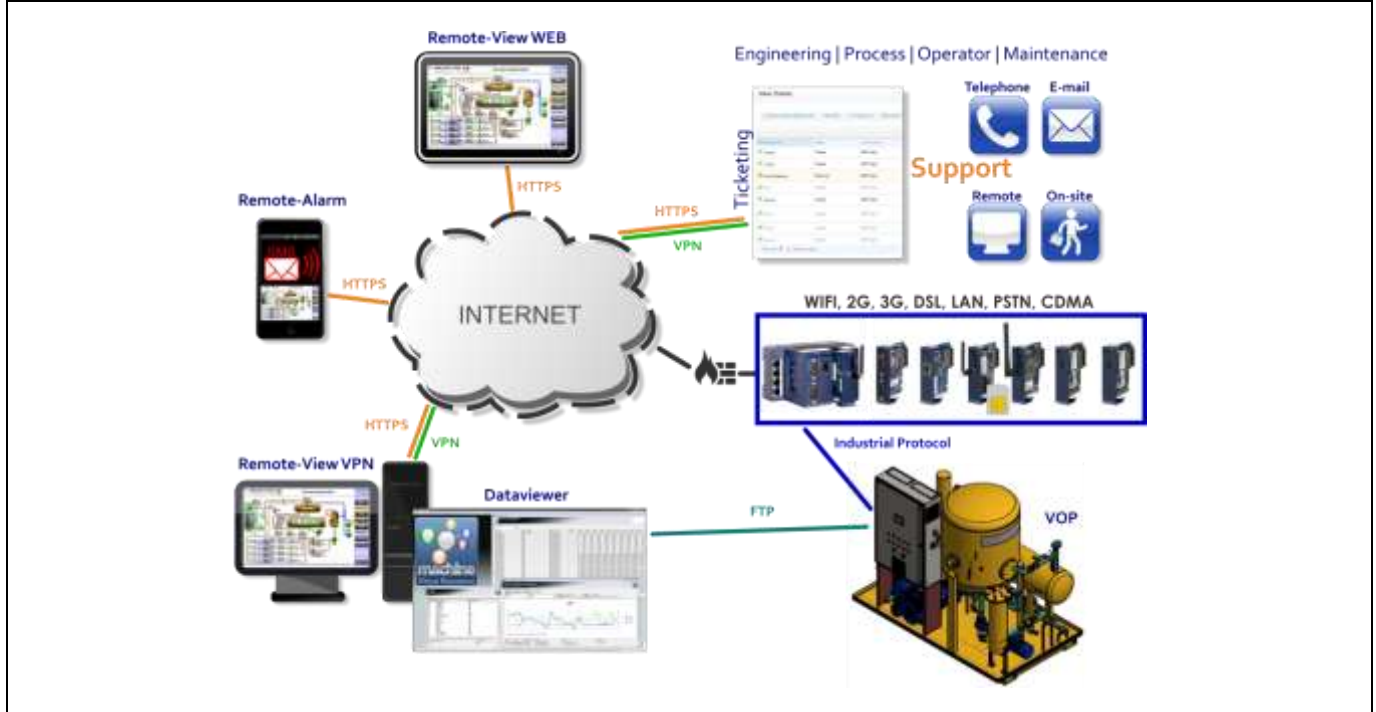

MVA Support Platform

Applications:

- Remote monitoring applications, with PLC interface for process supervision, alarm notification and datalogging.
- Remote management of the PLC control system as well as an animated web HMI interface.
- Control and monitoring through wireless technology via SMS.
- Alarm notification system of PLC variables (SMS, email, FTP, SNMP trap).

Capabilities:

- Ethernet WAN, 3G+ HSUPA, WiFi 802.11 b,g,n, ADSL, PSTN communication.
- Compliant with worldwide 3G/3G+ networks.
- HTTPS, FTP, RDP, VPN and WEB ready
- Communication security and dependability via an authenticated and encrypted connection to a centralized dedicated server.



MVA Package Pricelist 2014

| Zone - Country | None | | Support Packages | | | |
|--------------------------|--|------|---------------------|----------|----------|----------|
| Networks | None | None | Annual Subscription | | | |
| Service | Description | | Basic | Standard | Premium | Premium+ |
| Kick-Start | Machine registration and connection | N° | 1 | 2 | 3 | 4 |
| Com-Kit ⁶ | Communication equipment required / machine | N° | 1 | 0 | 0 | 0 |
| Machine Support | Max number of machines covered by respective package | N° | 1 | 2 | 3 | 4 |
| Engineering Support | Engineering centre of competence for operator, process, maintenance or troubleshooting support | Hrs | 2 | 5 | 10 | 25 |
| Support Data Traffic | Only for Zone 1A,1B,2 | MB | 20 | 50 | 100 | 250 |
| Remote-View WEB | Parallel WEB connections (One VNC Connection / HMI Panel / Mobile Device) | N° | - | - | <10 | <10 |
| Remote-View VPN | VPN Concurrent Connection(Windows Client Touch) | N° | - | - | - | 1 |
| Remote-View Data Traffic | Total data traffic ¹ for customer Remote View WEB & VPN | GB | - | - | 10 | 20 |
| Remote-Alarm (SMS) | Sms alarming to any customer mobile number | N° | Optional | Optional | 480 | 720 |
| Support | Remote support | | ✓ | ✓ | ✓ | ✓ |
| | Telephone support | | GPO ⁸ | ✓ | ✓ | ✓ |
| | E-mail support | | ✓ | ✓ | ✓ | ✓ |
| | Onsite support ² (Excl. spare parts, hotel and travelling costs) ³ | | - | - | - | ✓ |
| | Software updates (HMI, PLC and Com-Kit) | | ✓ | ✓ | ✓ | ✓ |
| Dataviewer | HMI Windows desktop process database, trending and reporting software | | Optional | Optional | Optional | ✓ |
| Labviewer | Windows desktop database and reporting software for insulation oil lab analysis | | Optional | Optional | Optional | Optional |

How does it work?

1. Consult Micafluid for a compatibility test of existing equipment where applicable
2. Simply choose from either the Basic, Standard, Premium or Premium+ packages according to the required support features listed above
3. Request a quotation based on country or countries where the equipment will be operable

Extension packages are also available for seamless service in every situation.

Z13 Rollers for indoor use only (e.g workshop)





2 swivelling and 2 fixed rollers with locking device.
These rollers are suitable only for even workshop floor.

| | |
|---|---|
| Z15 1 enclosure with tarpaulin cover | |
|  | <p>Built according to European Union standards protection against sun, rain and dust.</p> <p>This option is necessary for the enterprise of an on-line oil plant construction according to special standards against surcharge.</p> |

| | |
|---|---|
| Z15.1 1 enclosure with metal cover (Alternative to Z15) | |
| | <p>Rustproof and weatherproof metal cover. Built according to European Union standards protection against sun, rain and dust.</p> <p>This option is necessary for the enterprise of an on-line oil plant construction according to special standards against surcharge.</p> |

| | |
|---|---|
| Z16 1 roadworthy trailer with tarpaulin cover | |
|  | <p>Built according to European Union standards for the road transport of the dressing plant.</p> <p>The trailer is equipped with a rack and a tarpaulin roll upable on all sites.</p> <p>Maximum driving speed 80km/h</p> <p>Construction according to special standards against surcharge.</p> |

| | |
|---|--|
| Z17 1 roadworthy trailer with metal housing | |
|  | <p>Built according to European Union standards without local road permission.</p> <p>For the road transport of the dressing plant. The housing consists of lightweight construction material (e.g. aluminum, wood or plastic) with all necessary doors and service flaps.</p> <p>Maximum driving speed 80kmh</p> <p>Construction according to special standards against surcharge.</p> |

| | |
|---|--|
| Z18.1 1 set filter elements with 5 micron finess | |
|  | <p>Profile® II filters are all Nylon. The 5 micron elements have an absolute-rated downstream section, and a continuously graded pore size upstream section, which increases service life many-fold. The filter elements are 2 1/2" O.D. and are available in one piece 20" length modules.</p> <p>Rating efficiency= 99,9%</p> <p>Maximum pressure difference at 50°C = 3.5bar</p> <p>Maxium flow rate per cartridge = 1500lt/h</p> |

| | |
|--|--|
| Z19.1 1 set filter elements with 1 micron finess | |
|  | <p>Profile® II filters are all Nylon. The 1 micron elements have an absolute-rated downstream section, and a continuously graded pore size upstream section, which increases service life many-fold. The filter elements are 2 1/2" O.D. and are available in one piece 20" length modules.</p> <p>Rating efficiency= 99,9%</p> <p>Maximum pressure difference at 50°C = 3.5bar</p> <p>Maxium flow rate per cartridge = 1500lt/h</p> |

| | |
|---|---|
| Z20 Spare parts for 2 years | |
|  | <p>Sufficient for 2 years of maintenance of the plant (without commodity wares)</p> |

| | |
|--------------------------------------|---|
| Z20.1 Spare parts for 5 years | |
| | <p>Sufficient for 5 years of maintenance of the plant (without commodity wares)</p> |

VI. Drawings

Piping diagram:

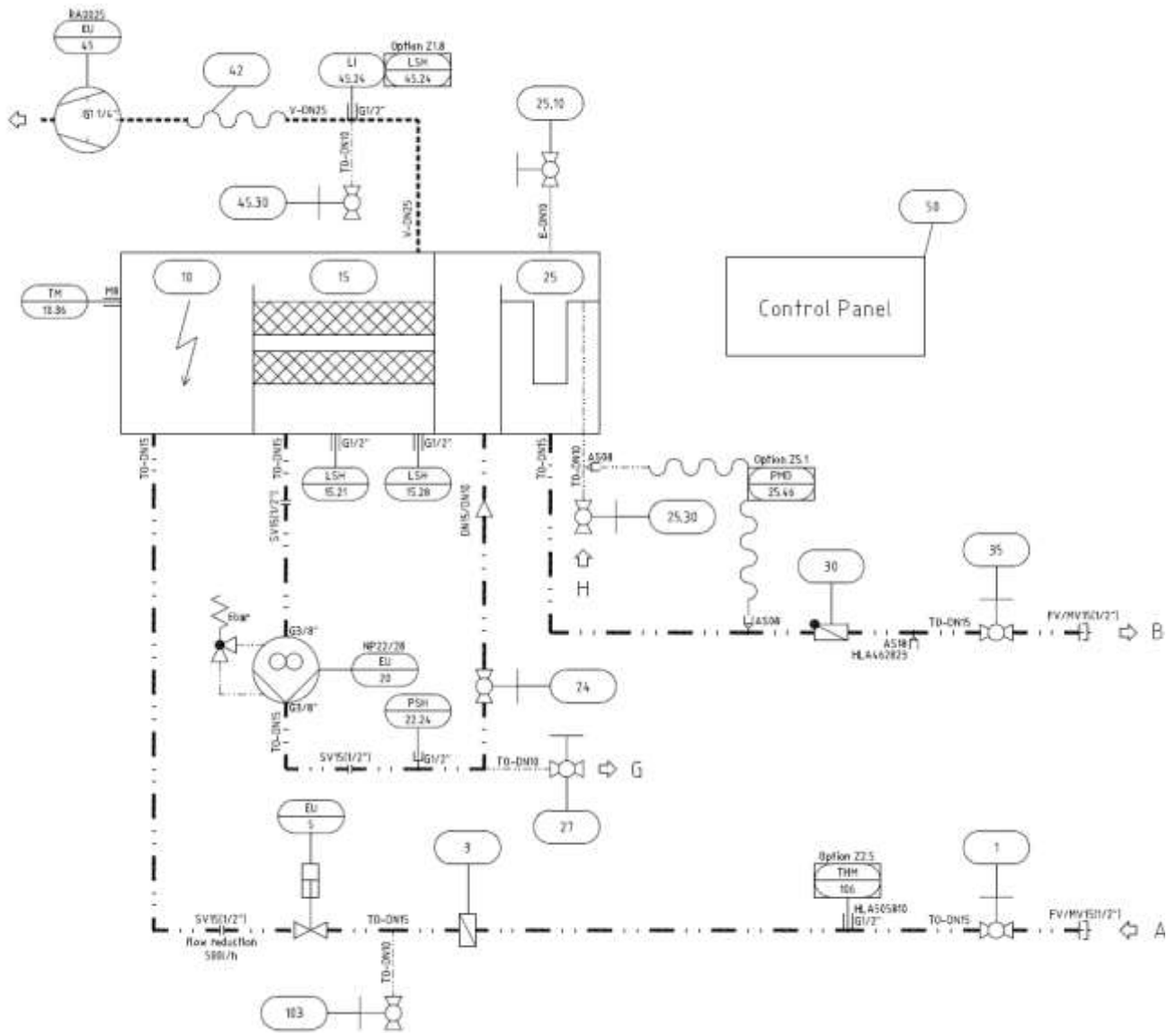

Subject to alterations.

Lay Out:

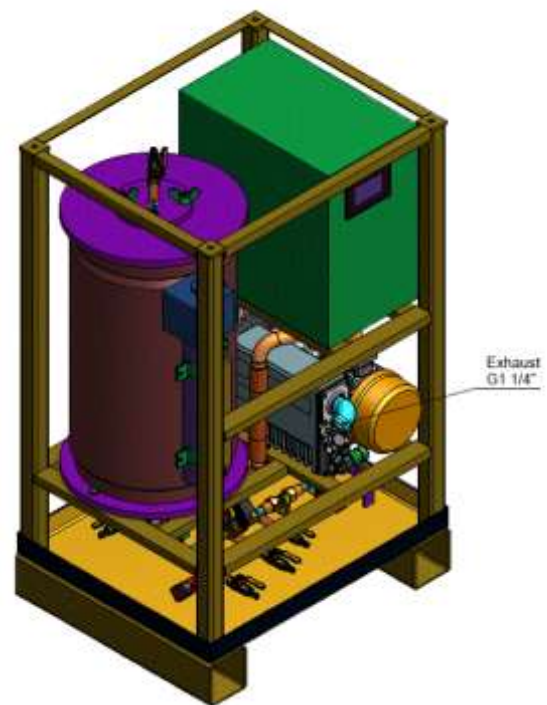
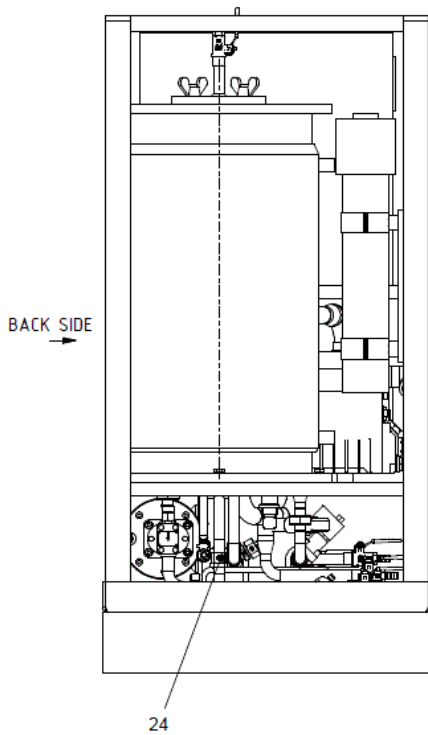
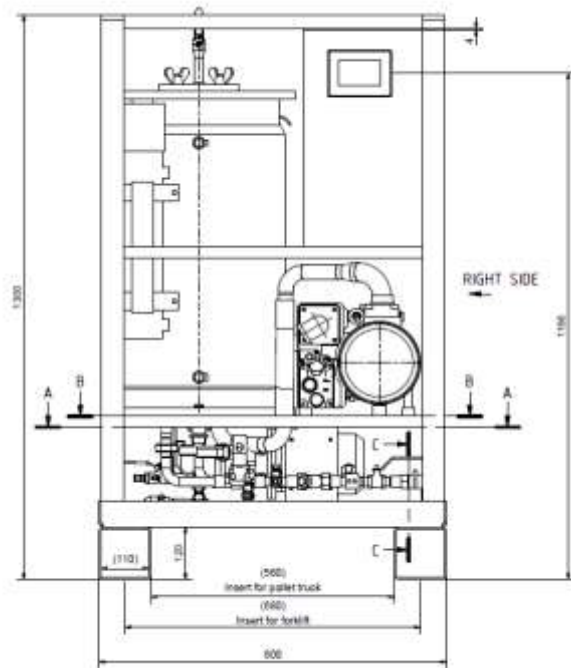
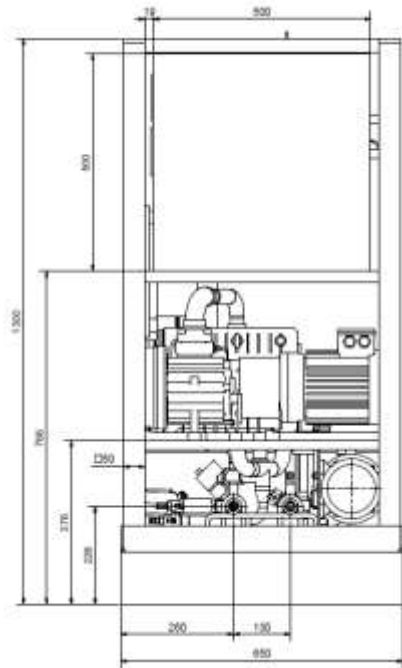

Approx. Dimension and weight VLP05-online

- Length: 1000 mm
- Wide: 800 mm
- Heigth: 1'500 mm
- Weight: ca. 650 kg